

FLIGHT THEORY



ATPL ANNEXES 021

Rev. W

Figure 021-03

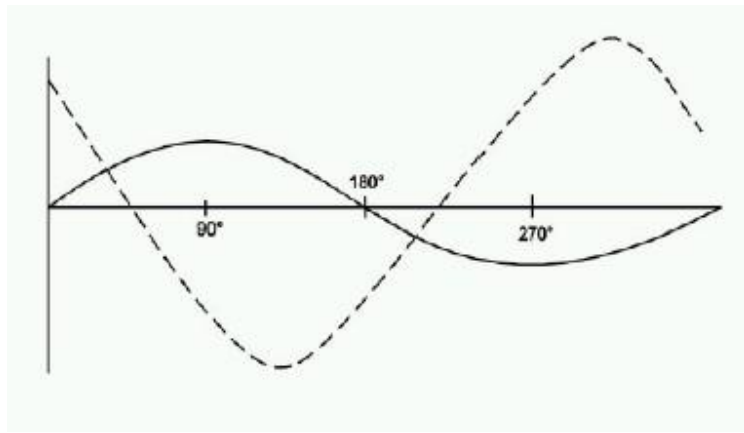

021-05

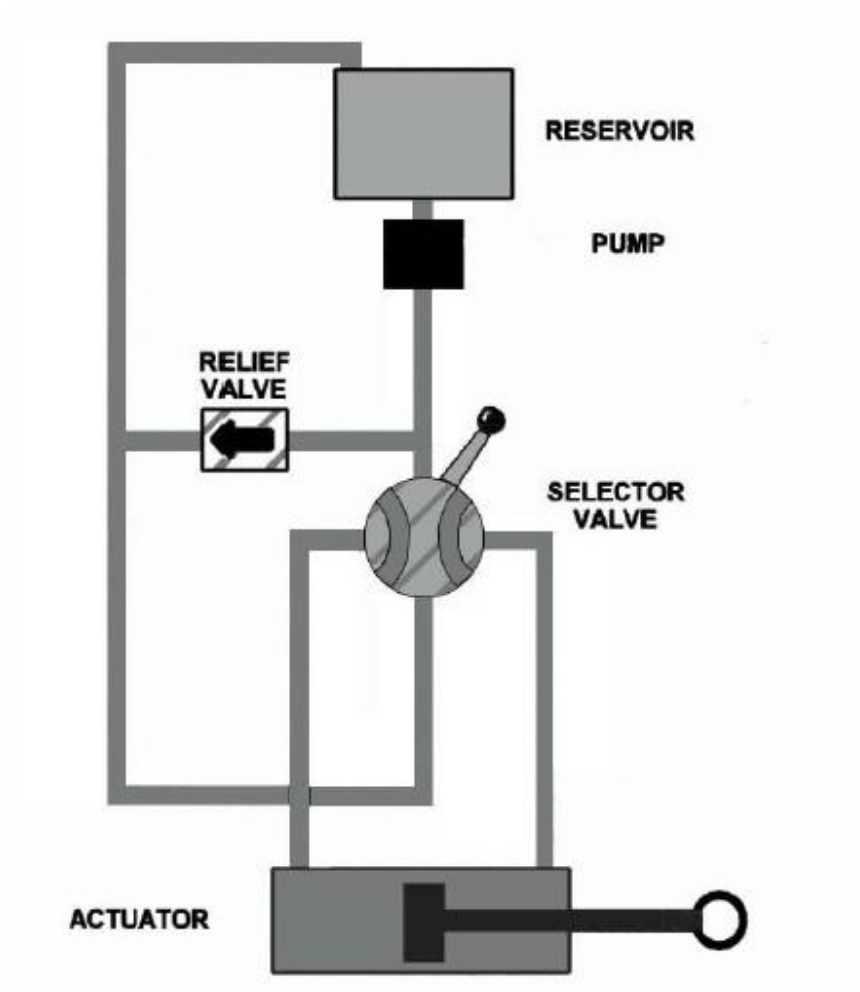

021-12

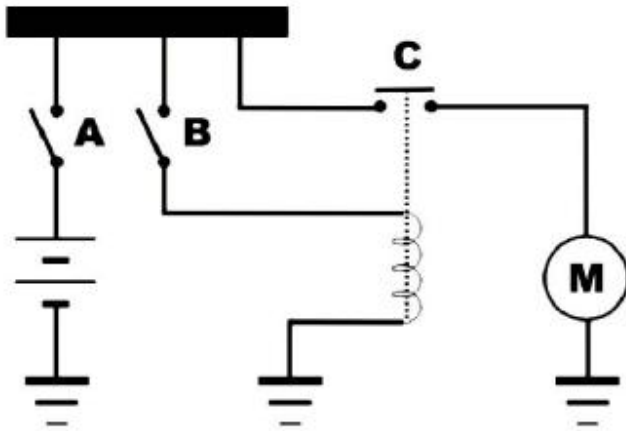

021-16

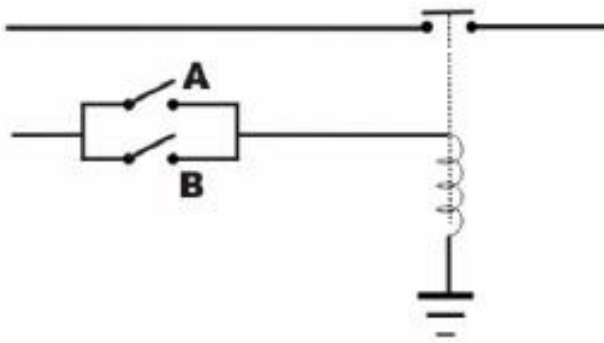

Figure 021-17

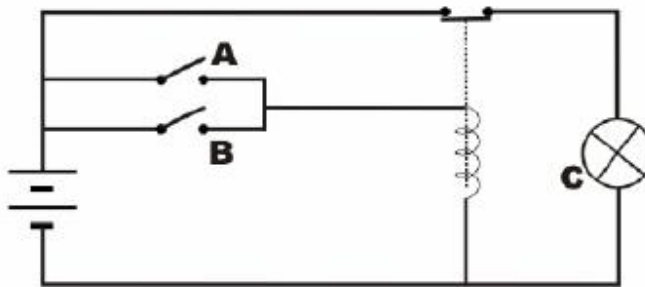

Figure 021-18

| Input A | Input B | OUTPUT |
|---------|---------|--------|
| 0 | 0 | 0 |
| 0 | 1 | 1 |
| 1 | 0 | 1 |
| 1 | 1 | 0 |

Figure 021-19

| Input A | Input B | OUTPUT |
|---------|---------|--------|
| 0 | 0 | 1 |
| 0 | 1 | 0 |
| 1 | 0 | 0 |
| 1 | 1 | 0 |

Figure 021-20

| Input A | Input B | OUTPUT |
|---------|---------|--------|
| 0 | 0 | 1 |
| 0 | 1 | 1 |
| 1 | 0 | 1 |
| 1 | 1 | 0 |

Figure 021-21

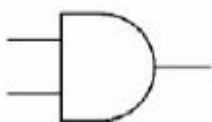

Figure 021-22

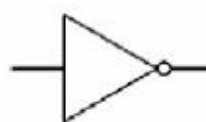

Figure 021-23

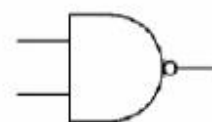

Figure 021-24

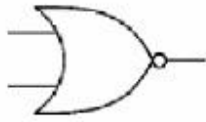

Figure 021-25

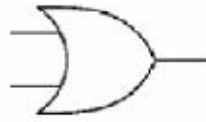

Figure 021-26

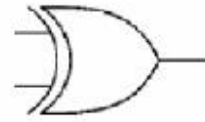

Figure 021-27

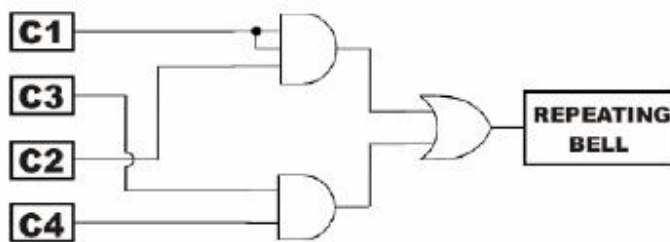

Figure 021-28

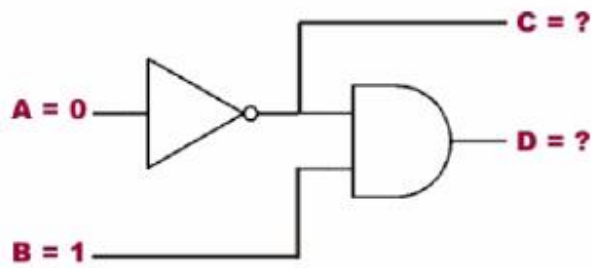

Figure 021-29

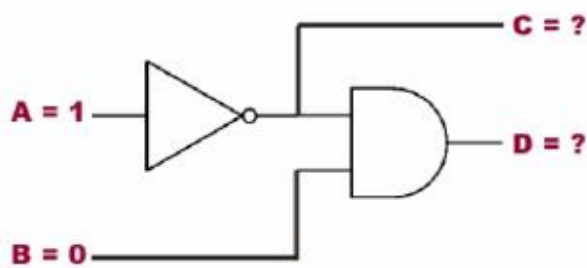

Figure 021-30

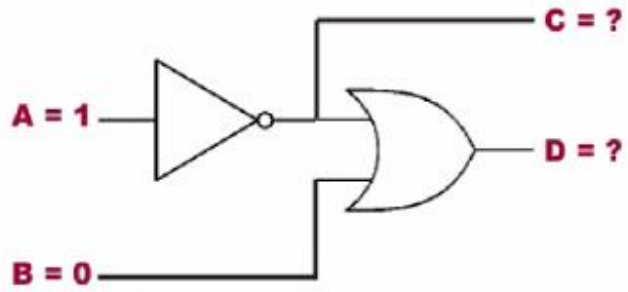

Figure 02-31

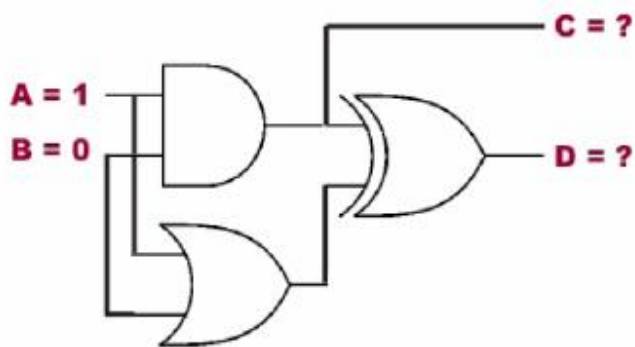
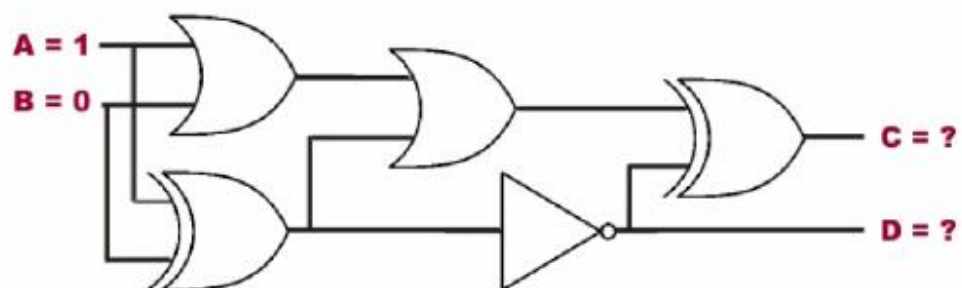

Figure 021-32



021-100 A



021-101 A

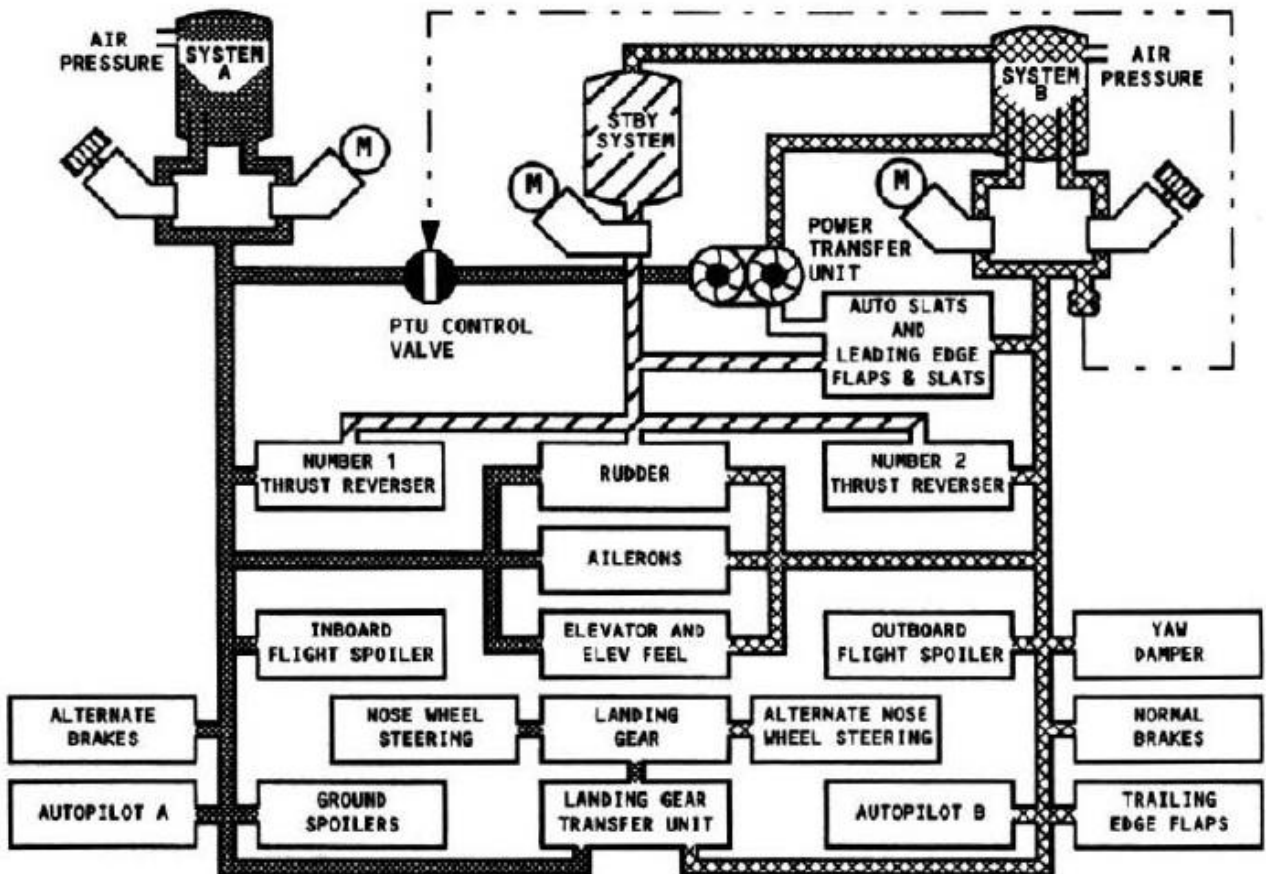

021-786 A

B. 747
AIR FRANCE

TU
DO.NT

Conduif du vol

Performances
generalites

62. 20. 05
FEV. 84

ATMOSPHERE STANDARD

| ALTITUDE Pieds | TEMPERATURE | | PRESSION | | | | RAPPORT de PRESSION $\delta = P / P_o$ | IDENSITE RELATIVE $\delta = \rho / \rho_o$ | $\sqrt{\text{DENSITE}}$ | VITESSE du SON (a) kt | ALTITUDE Metres |
|-------------------|-------------|--------|-------------|-------|----------|----------|--|--|-------------------------|--------------------------------|--------------------|
| | °C | ° F | mb | P S 1 | In Hg | mm Hg | | | | | |
| 45.000 | - 56,5 | - 69,7 | 147 | 2,14 | 4,36 | 110,7 | 0,1415 | 0,1936 | 0,440 | 574 | 13, 716 |
| 44.000 | - 56,5 | - 69,7 | 155 | 2,24 | 4,57 | 116,0 | 0,1527 | 0,2031 | 0,451 | 574 | 13, 411 |
| 43.000 | - 56,5 | - 69,7 | 162 | 2,35 | 4,79 | 121,7 | 0,1602 | 0,2131 | 0,462 | 574 | 13, 106 |
| 42.000 | - 56,5 | - 69,7 | 170 | 2,47 | 5,03 | 127,8 | 0,1681 | 0,2236 | 0,473 | 574 | 12, 802 |
| 41.000 | - 56,5 | - 69,7 | 179 | 2,19 | 5,28 | 134,1 | 0,1764 | 0,2346 | 0,484 | 574 | 12, 497 |
| 40.000 | - 56,5 | - 69,7 | 188 | 2,72 | 5,54 | 140,7 | 0,1851 | 0,2462 | 0,496 | 574 | 12, 192 |
| 39.000 | - 56,5 | - 69,7 | 197 | 2,81 | 5,81 | 147,6 | 0,1942 | 0,2583 | 0,508 | 574 | 11, 887 |
| 38.000 | - 56,5 | - 69,7 | 206 | 2,99 | 6,10 | 154,9 | 0,2018 | 0,2710 | 0,521 | 574 | 11, 582 |
| 37.000 | 56,5 | - 69,7 | 217 | 3,14 | 6,40 | 162,6 | 0,2138 | 0,2843 | 0,533 | 574 | 11, 278 |
| 36.000 | - 56,3 | - 69,4 | 227 | 3,30 | 6,71 | 170,4 | 0,2243 | 0,2981 | 0,546 | 574 | 10, 973 |
| 35.000 | - 54,3 | - 65,8 | 238 | 3,46 | 7,04 | 178,8 | 0,2353 | 0,3099 | 0,557 | 576 | 10, 668 |
| 34.000 | - 52,4 | - 62,3 | 250 | 3,63 | 7,38 | 187,5 | 0,2467 | 0,3220 | 0,167 | 579 | 10, 363 |
| 33.000 | - 50,4 | - 58,7 | 262 | 3,80 | 7,74 | 196,6 | 0,2586 | 0,3345 | 0,578 | 582 | 10, 058 |
| 32.000 | - 48,4 | - 55,1 | 274 | 3,98 | 8,11 | 206,0 | 0,2709 | 0,3473 | 0,589 | 584 | 9, 754 |
| 31.000 | - 46,4 | - 51,6 | 287 | 4,17 | 8,49 | 215,6 | 0,2837 | 0,3605 | 0,600 | 587 | 9, 449 |
| 30.000 | - 44,4 | - 48,0 | 301 | 4,36 | 8,89 | 225,8 | 0,2970 | 0,3741 | 0,611 | 589 | 9, 144 |
| 29.000 | - 42,5 | - 44,4 | 315 | 4,57 | 9,30 | 256,2 | 0,3107 | 0,3881 | 0,623 | 591 | 8, 839 |
| 28.000 | - 40,5 | - 40,9 | 329 | 4,78 | 9,73 | 247,1 | 0,3250 | 0,4025 | 0,634 | 594 | 8, 534 |
| 27.000 | - 38,5 | - 37,3 | 344 | 4,99 | 10,17 | 258,3 | 0,3398 | 0,4173 | 0,646 | 597 | 8, 230 |
| 26.000 | - 36,5 | - 33,7 | 360 | 5,22 | 10,63 | 270,0 | 0,3552 | 0,4325 | 0,658 | 599 | 7, 925 |
| 25.000 | - 34,5 | - 30,2 | 376 | 5,45 | 11,10 | 281,9 | 0,3711 | 0,4481 | 0,669 | 602 | 7, 620 |
| 24.000 | - 32,5 | - 26,6 | 393 | 5,70 | 11,60 | 294,6 | 0,3876 | 0,4642 | 0,681 | 604 | 7, 315 |
| 23.000 | - 30,6 | - 23,0 | 410 | 5,95 | 12,11 | 307,6 | 0,4047 | 0,4806 | 0,693 | 607 | 7, 010 |
| 22.000 | - 28,6 | - 19,5 | 428 | 6,21 | 12,64 | 321,1 | 0,4223 | 0,4976 | 0,705 | 609 | 6, 706 |
| 21.000 | - 26,6 | - 15,9 | 446 | 6,47 | 13,18 | 334,8 | 0,4406 | 0,5150 | 0,718 | 612 | 6, 401 |
| 20.000 | - 24,6 | - 12,3 | 466 | 6,75 | 13,75 | 349,3 | 0,4596 | 0,5328 | 0,730 | 614 | 6, 096 |
| 19.000 | - 22,6 | - 8,8 | 485 | 7,04 | 14,34 | 364,2 | 0,4791 | 0,5511 | 0,742 | 617 | 5, 791 |
| 18.000 | - 20,7 | - 5,2 | 506 | 7,34 | 14,94 | 379,5 | 0,4994 | 0,5699 | 0,755 | 619 | 5, 486 |
| 17.000 | - 18,7 | - 1,6 | 527 | 7,65 | 15,57 | 395,5 | 0,5203 | 0,5892 | 0,768 | 622 | 5, 182 |
| 16.000 | - 16,7 | + 1,9 | 549 | 7,97 | 16,22 | 412,0 | 0,5420 | 0,6089 | 0,780 | 624 | 4, 877 |
| 15.000 | - 14,7 | + 5,5 | 572 | 8,29 | 16,89 | 429,0 | 0,5644 | 0,6292 | 0,793 | 626 | 4, 572 |
| 14.000 | - 12,7 | + 9,1 | 595 | 8,63 | 17,58 | 446,1 | 0,5875 | 0,6500 | 0,806 | 629 | 4, 267 |
| 13.000 | - 10,7 | + 12,6 | 619 | 8,99 | 18,29 | 464,6 | 0,6113 | 0,6713 | 0,819 | 631 | 3, 962 |
| 12.000 | - 8,8 | + 16,2 | 644 | 9,35 | 19,03 | 483,4 | 0,6360 | 0,6932 | 0,833 | 634 | 3, 658 |
| 11.000 | - 6,8 | + 19,8 | 670 | 9,72 | 19,79 | 502,7 | 0,6614 | 0,7155 | 0,846 | 636 | 3, 353 |
| 10.000 | - 4,8 | + 23,3 | 697 | 10,11 | 20,58 | 522,7 | 0,6877 | 0,7385 | 0,859 | 638 | 3, 048 |
| 9.000 | - 2,8 | + 26,9 | 724 | 10,50 | 21,39 | 543,3 | 0,7148 | 0,7619 | 0,873 | 641 | 2, 743 |
| 8.000 | - 0,8 | + 30,5 | 753 | 10,92 | 22,23 | 564,6 | 0,7428 | 0,7860 | 0,887 | 643 | 2, 438 |
| 7.000 | + 1,1 | + 34,0 | 782 | 11,34 | 23,09 | 586,5 | 0,7716 | 0,8106 | 0,900 | 645 | 2, 134 |
| 6.000 | + 3,1 | + 37,6 | 812 | 11,78 | 23,98 | 609,1 | 0,8014 | 0,8358 | 0,914 | 648 | 1, 829 |
| 5.000 | + 5,1 | + 41,2 | 843 | 12,23 | 24,90 | 652,5 | 0,8321 | 0,8616 | 0,928 | 650 | 1, 524 |
| 4.000 | + 7,1 | + 44,7 | 875 | 12,69 | 21,84 | 656,3 | 0,8037 | 0,8881 | 0,942 | 652 | 1, 219 |
| 3.000 | + 9,1 | + 48,3 | 908 | 13,17 | 26,82 | 681,2 | 0,8962 | 0,9151 | 0,957 | 655 | 914 |
| 2.000 | + 11,0 | + 51,9 | 942 | 13,66 | 27,82 | 706,6 | 0,9298 | 0,9427 | 0,971 | 657 | 610 |
| 1.000 | + 13,0 | + 55,4 | 977 | 14,17 | 28,86 | 733,0 | 0,9644 | 0,9710 | 0,985 | 659 | 305 |
| 0 | + 15,0 | + 59,0 | 1013 | 14,70 | 29,92 | 760,0 | 1,0000 | 1,0000 | 1,000 | 661 | 0 |
| 1.000 | + 17,0 | + 62,5 | 1050 | 15,23 | 31,02 | 787,9 | 1,0366 | 1,0295 | 1,015 | 664 | -305 |

021-980 A

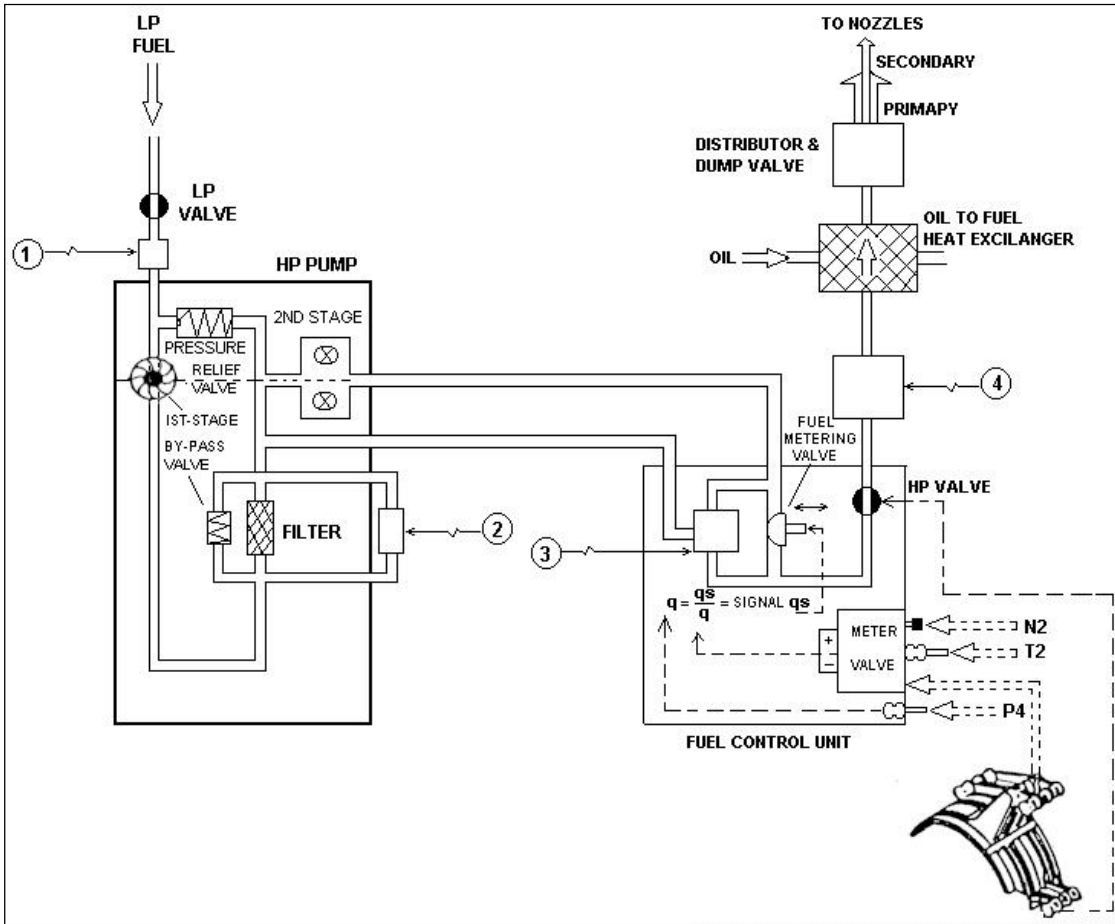

021-4008 A

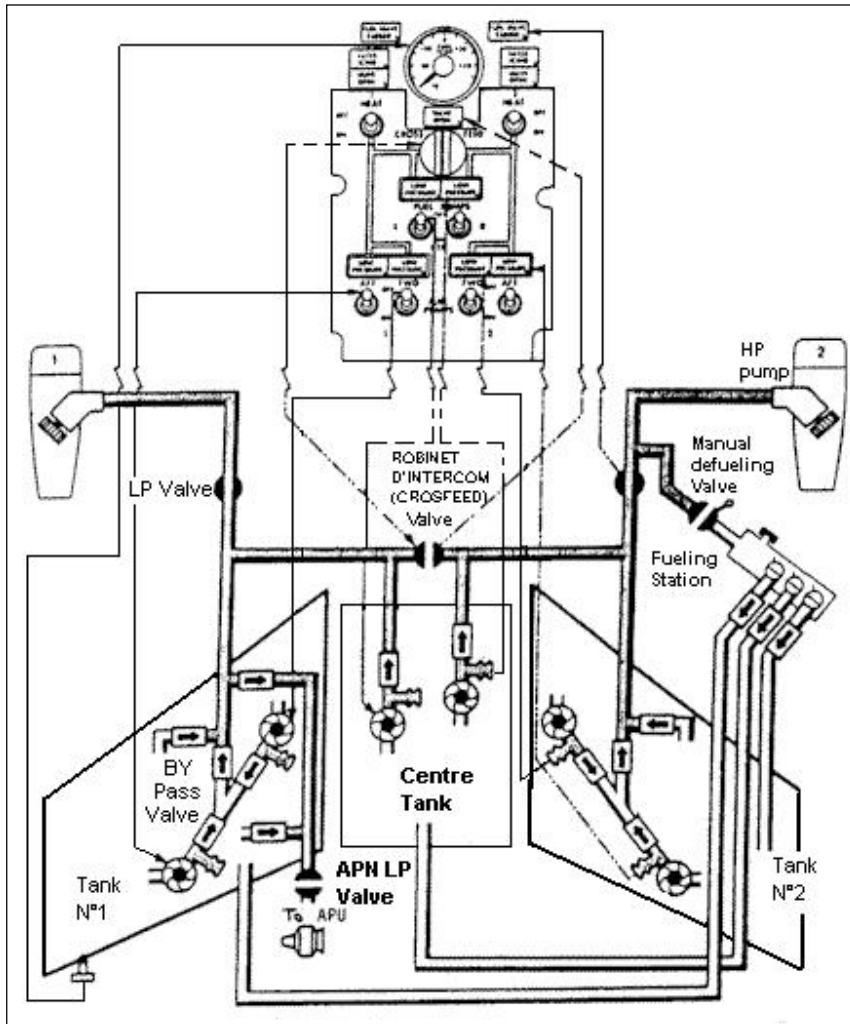

021-4960 A

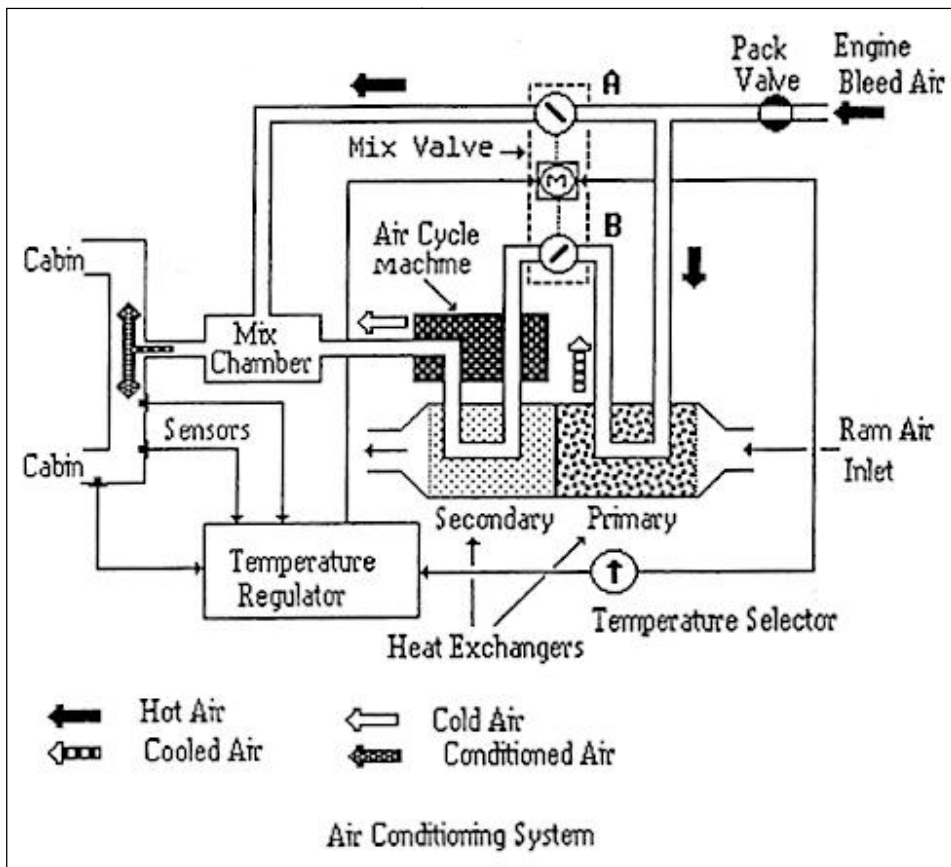

021-5248 A

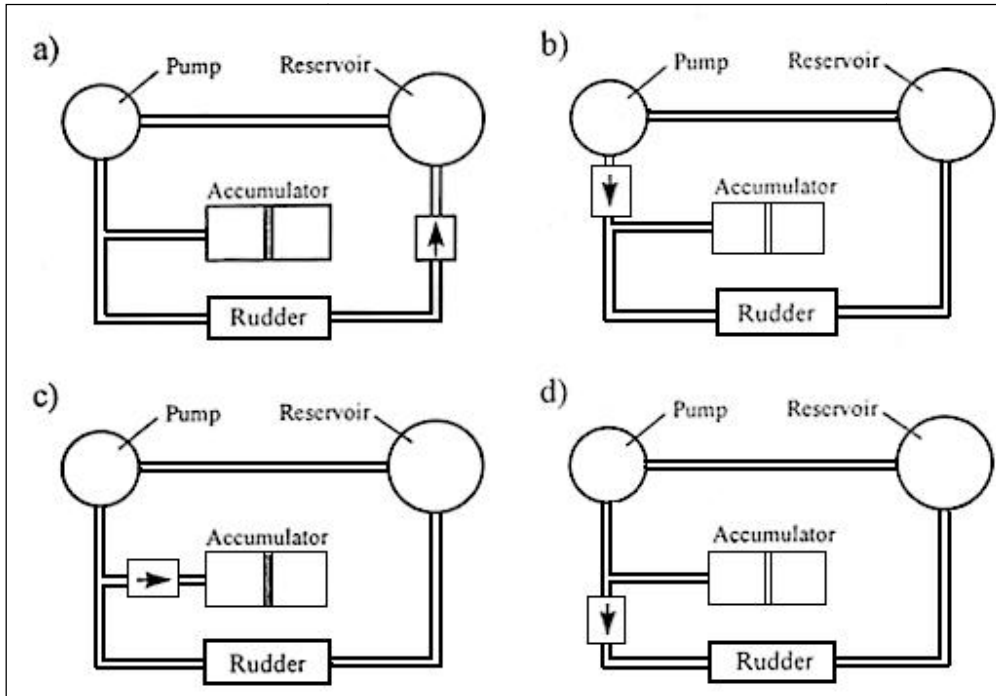

021-6660 A

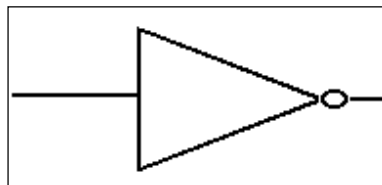

021-6716 A

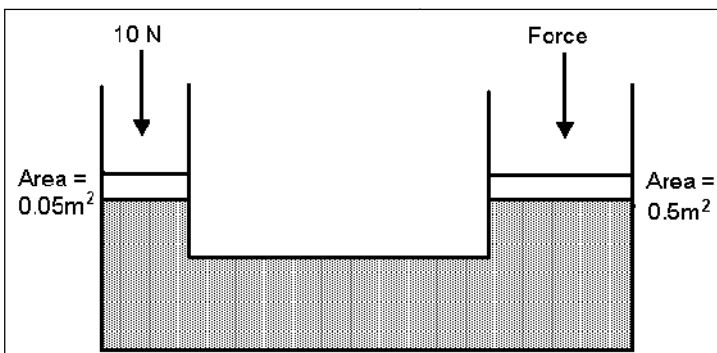

021-10164 A

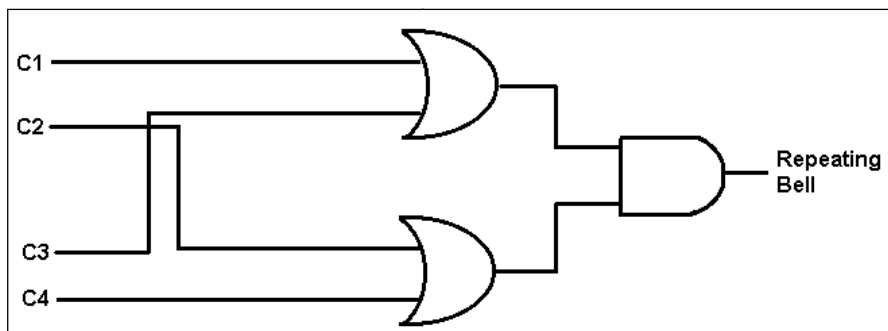

021-11474 A

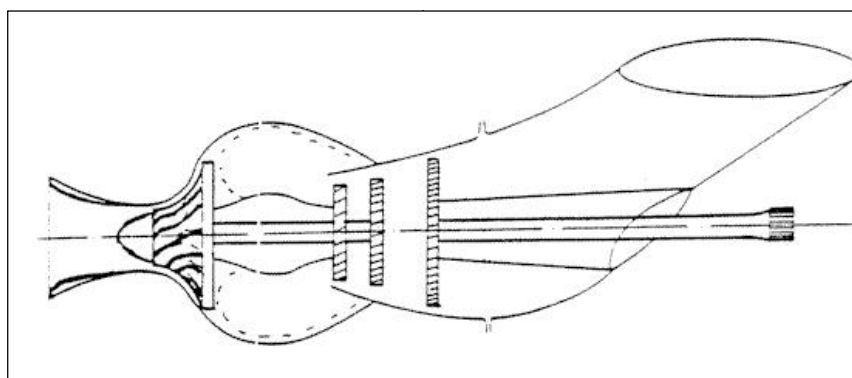

021-11494 A

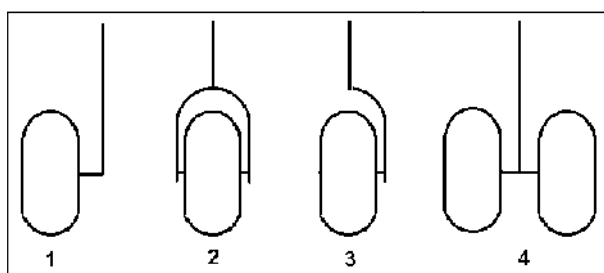

021-11507 A

